

QUIK DROP™

DUO



PLACE SERIAL NUMBER LABEL HERE



FACTORY CONTACT INFORMATION



BAY TEK GAMES INC.
Pulaski Industrial Park
1077 East. Glenbrook Drive
Pulaski, WI 54162 USA

JOIN OUR SERVICE FIRST NETWORK!

This free service is intended to keep you up to date on the latest game information, early notification of parts specials, pertinent technical bulletins, updates on retro fit parts, software upgrades, and much more.

Log on to: www.baytekgames.com/parts
then click on the Parts N' Service tab, or scan the QR code below with your Smartphone to jump straight to this game's parts page!

SALES

P: 920.822.3951

F: 920.822.8936

E: sales@baytekgames.com

PARTS

P: 920.822.3951 X 1101

F: 920.822.1496

E: parts@baytekgames.com

SERVICE

P: 920.822.3951 X 1102

F: 920.822.1496

E: service@baytekgames.com

MON - FRI
8 AM - 5 PM C.S.T.

All games are proudly manufactured at our factory in Pulaski, Wisconsin, USA

TABLE OF CONTENTS

FACTORY CONTACT INFORMATION	2
WELCOME TO: Quik Drop	4
GAME SPECIFICATIONS	5
LINKING KIT SETUP GUIDE	6-14
LINKING KIT LED DIAGRAM	15
DIP SWITCH SETTINGS	16
WIRING DIAGRAMS.....	17-18
TROUBLESHOOTING	19-20
DIAGNOSTICS	21
PARTS LIST	22
TECHNICAL SUPPORT	23
WARRANTY	24

WELCOME TO: Quik Drop

Congratulations on your Quik Drop purchase!

Quik Drop's attention-grabbing cabinet and fast-paced, addictive game play will have your buckets overflowing with profits!

Please take a moment to read through this manual and be sure to contact our factory if you have any questions, or would like some more information.

Thank you for your purchase! Your business is important to us and we hope you enjoy this game as much as we do!

Your Friends at Bay Tek Games



GAME INSPECTION

Inspect the game for any damaged, loose, or missing parts.

If damage is found, please contact your freight carrier first.

Then, contact Bay Tek Games' Service Department at 920.822.3951 or e-mail them at service@baytekgames.com for further assistance.













GAME SPECIFICATIONS

WEIGHT	
NET WEIGHT	600 LBS.
SHIP WEIGHT	700 LBS.
DIMENSIONS	
WIDTH	38.5"
DEPTH	44"
HEIGHT	109" (adjusts to 107", 116", 123")
OPERATING TEMPERATURE	
FAHRENHEIT	80-100
CELSIUS	26.7-37.8

POWER REQUIREMENTS			
INPUT VOLTAGE RANGE	100 to 120 VAC	/	220 to 240 VAC
INPUT FREQUENCY RANGE	50 HZ	/	60 HZ

MAX OPERATING CURRENT	
1.4 AMPS @ 115 VAC	
.8 AMPS @ 230 VAC	

SAFETY PRECAUTIONS

	NOTICE	
<p>Modifications to the mechanical, electrical and structural components of this game may void its compliance certifications.</p> <p>This appliance is suitable for INDOOR, DRY locations only.</p> <p>Not for use in altitudes above 2,000 meters</p>		
	DANGER	
<p>DO NOT perform repairs or maintenance on this game with the power ON. Unplug the unit from the wall outlet or shut off the power strip located inside the cabinet.</p>		
	WARNING	
<p>Use of flammable substances can cause sever burns or serious injury. Always use NON-FLAMMABLE solvents for cleaning. DO NOT use gasoline, kerosene or thinners.</p>		
	CAUTION	
<p>Lifting heavy objects can cause back, neck or other injuries. Be sure adequate lifting and moving devices are available when unloading, unpacking and moving this game.</p>		
	ATTENTION	
<p>Be sure the electrical power matches the game requirements. See the serial number located on the back of the game cabinet. Always plug into a grounded circuit. If the supply cord is damaged, it must be replaced by an approved cord or assembly provided by the manufacturer. A shielded power cable must be used for the game to retain EU/EMC compliance.</p>		
	IN CASE OF EMERGENCY	
<p>UNPLUG THE POWER CORD. The power cord must be accessible at all times in case of an emergency.</p>		

DUO SETUP GUIDE

Included hardware kit for Quik Drop
Linking kit



Unscrew two screws

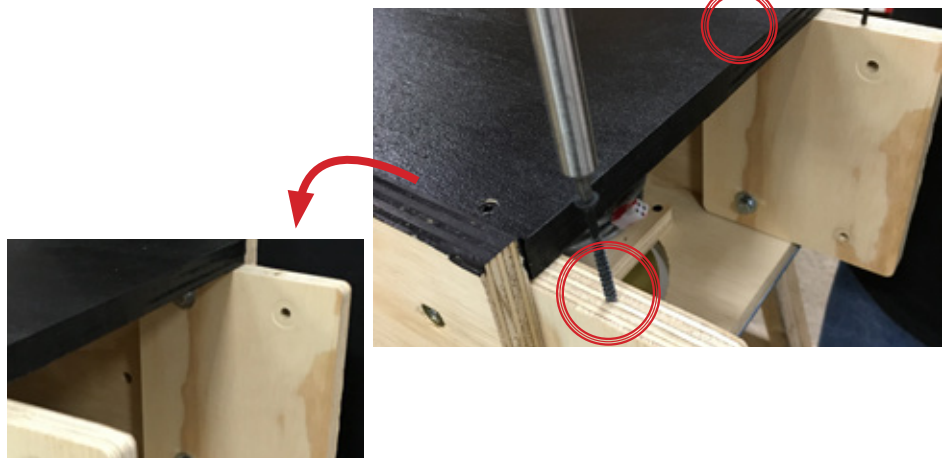

Lay top of linking kit face down



Unscrew and remove the back

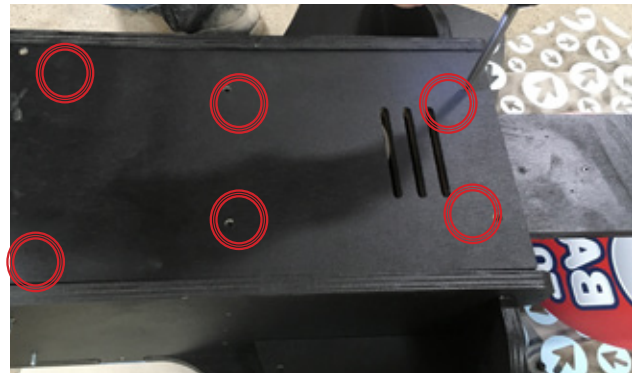

DUO SETUP GUIDE

Remove 4 bolts

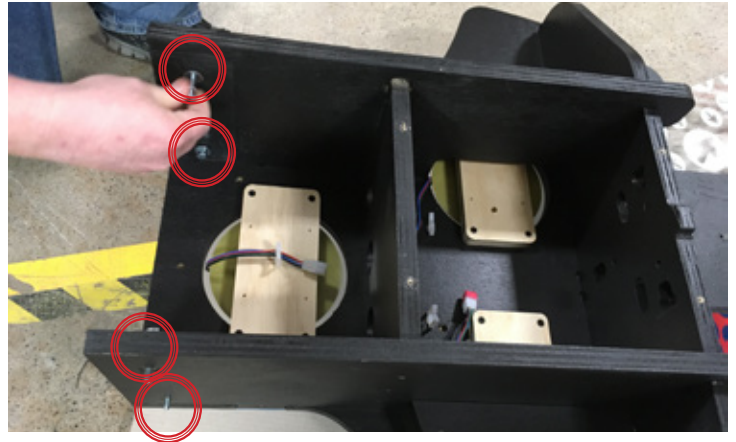

Stand bottom part of linking kit up and slide top piece in place



Secure top to bottom with the 4 bolts that were previously removed

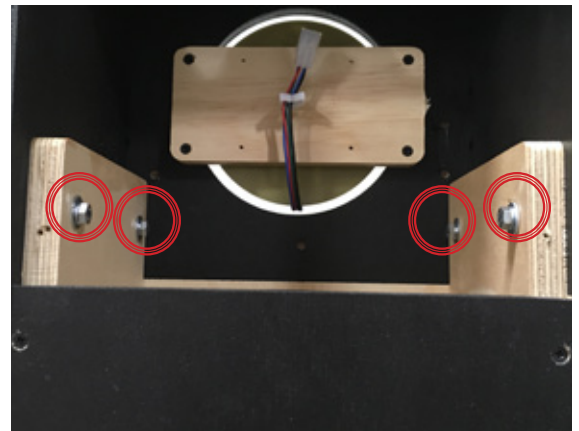

Remove the back of bottom piece

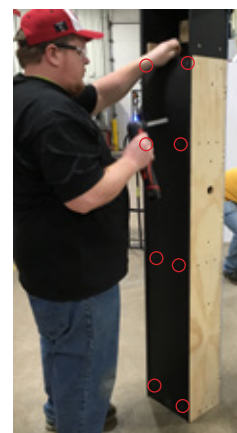

DUO SETUP GUIDE

Red CE5861 goes up through opening to top piece of linking kit to connect to other red cord(right globe). Clip into saddle

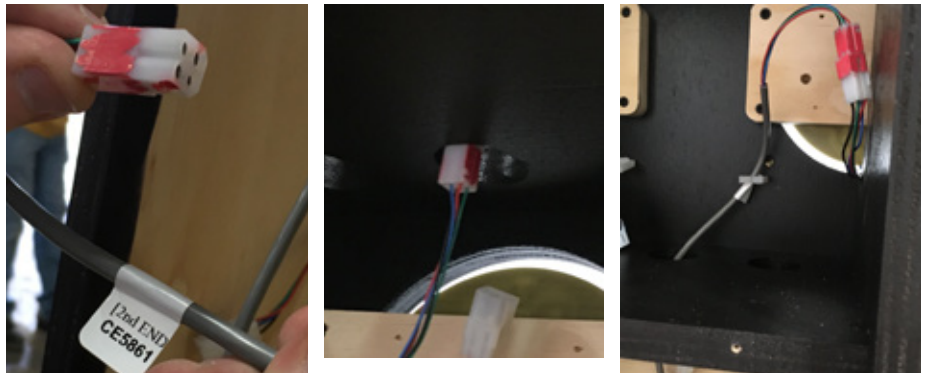

Black CE5862 goes up through opening to top piece of linking kit to connect to other black cord(left globe)

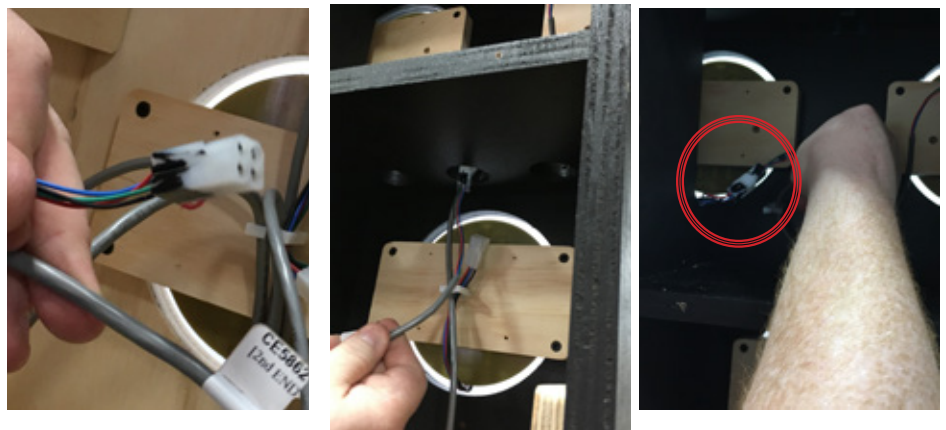

CE5863 connect to matching cord

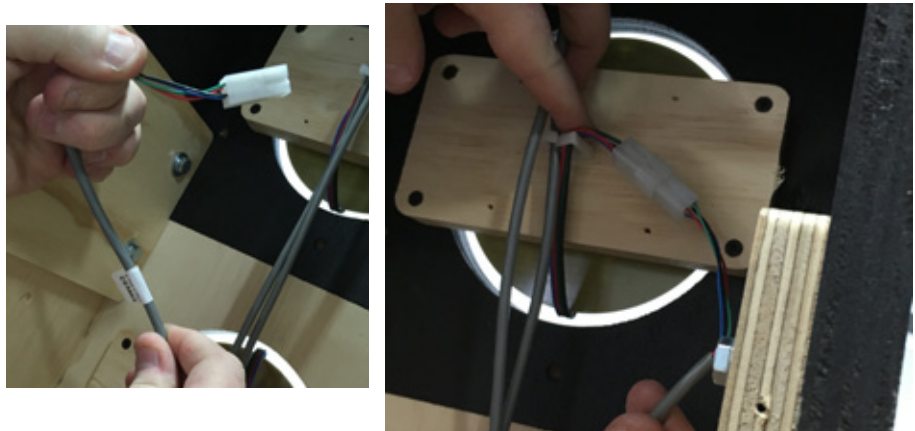

The cord with two housings goes up the opening to the top part of linking kit

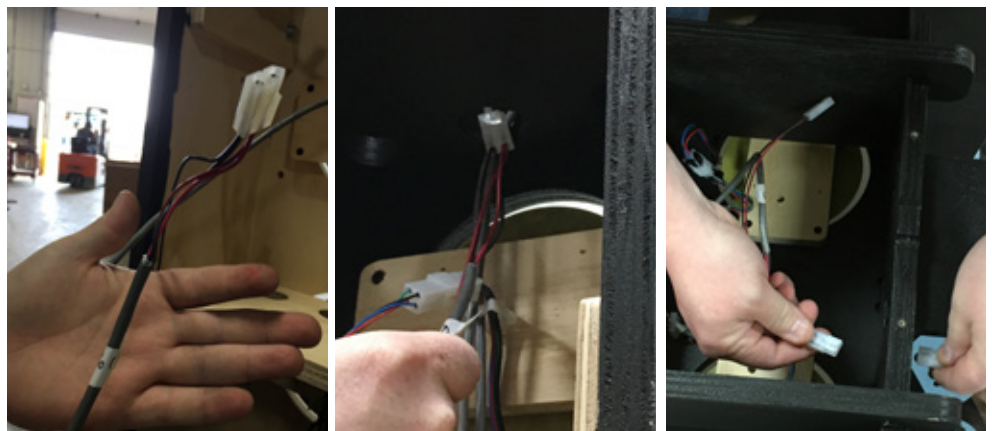

DUO SETUP GUIDE

Then take the cord and put it through another opening at the top of the top linking kit to attach to the left cord



Connect other end of cord to the right cord on top. Then pull excess cord into the cabinet of the top part of the linking kit



Screw the back of the top linking kit into place



DUO SETUP GUIDE

Tip the whole linking kit into a vertical position

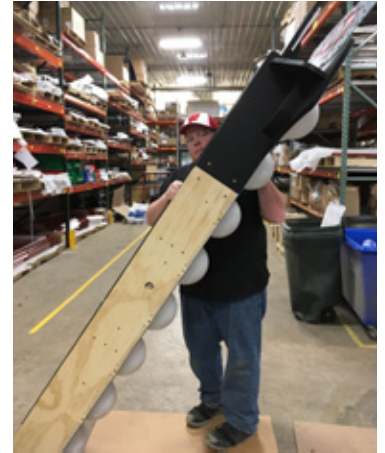

Take the paper template out of the box

Place paper template along top edge of the game. Tape in place



Make sure there are no cords in line with template screw holes before drilling.

*Use a 3/8 drill bit for holes.

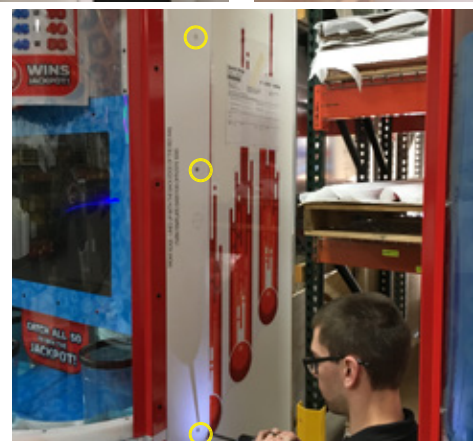
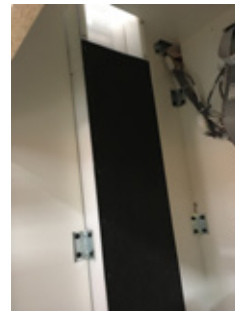

DUO SETUP GUIDE

Use a 13/16 spade bit in the large hole in the paper template



Drill hole all the way through



Repeat process on the other Quik Drop

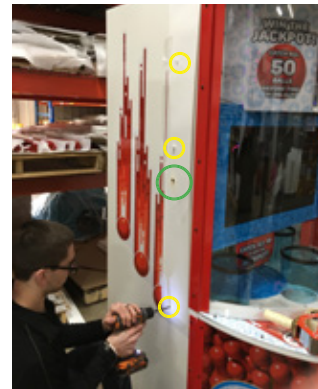

DUO SETUP GUIDE

Using the hardware below insert bolts into 3/8 inch holes in one side. Make sure there is one washer on the bolt before inserting it

Included hardware: 6 bolts, 12 washers, 6 nuts
Tools needed: 1/2 wrench or socket

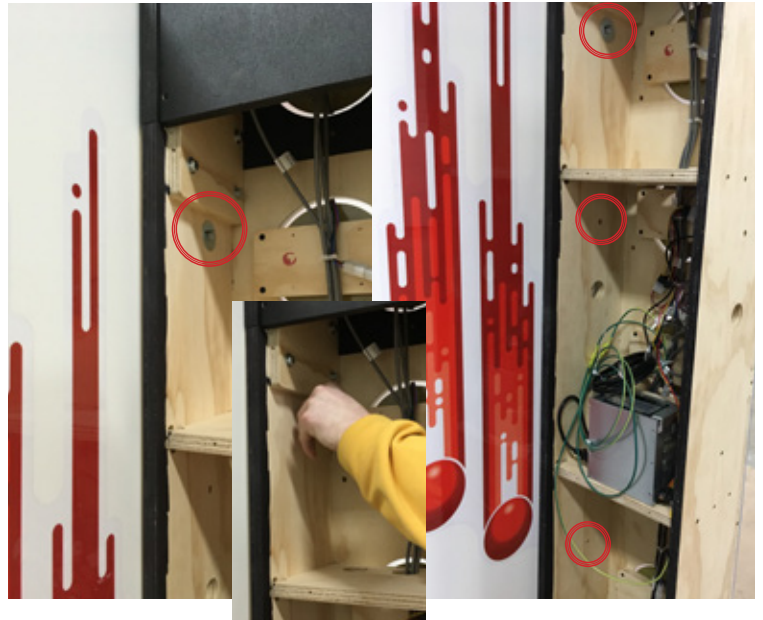

Tighten bolts by holding the wrench on the nut while tightening with the socket

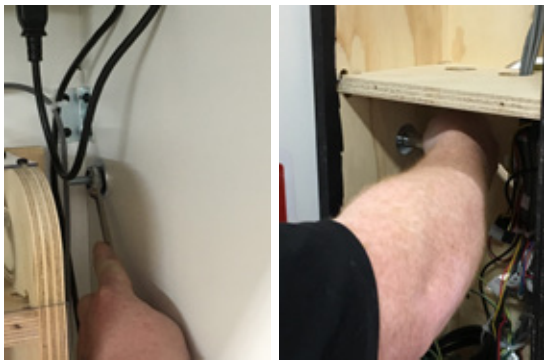

REPEAT LAST TWO STEPS ON THE OTHER SIDE



DUO SETUP GUIDE

Cut zip tie of black HDMI and insert through right hole of the right Quik Drop game and connect to circuit board



Take one of the green and yellow cords and thread it through the right hole to the right Quik Drop game

Unscrew screw from the steel and add the green and yellow cord to it. Screw back in place

Repeat process with other green and yellow cord with the left Quik Drop game
*Steel box will be closer to the connecting hole than the right Quik Drop game

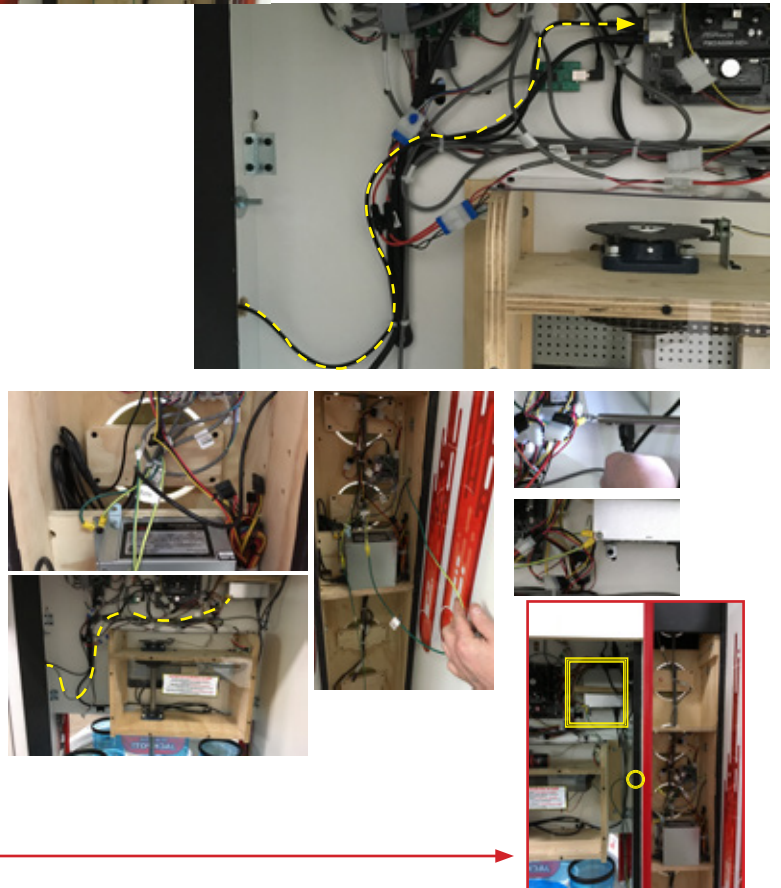

Take ethernet crossover cable and thread it through both holes. This cord will allow the two games to communicate

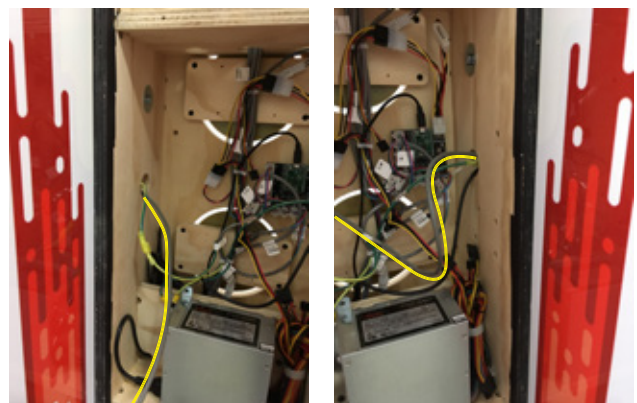

DUO SETUP GUIDE

Plug in ethernet crossover cable right above the HDMI cord on both games

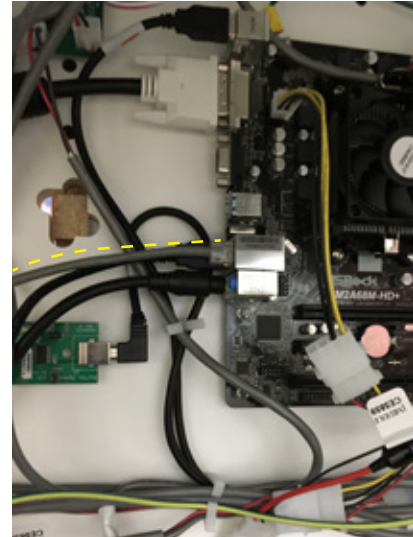

Screw the back of linking kit into place and plug in the game



Pull up the main menu. Scroll down to Machine ID. When standing in front of the games, they will be numbered from left to right. The left-most unit will be #1. Make sure the number next to machine ID reads 1 for the left-most unit.

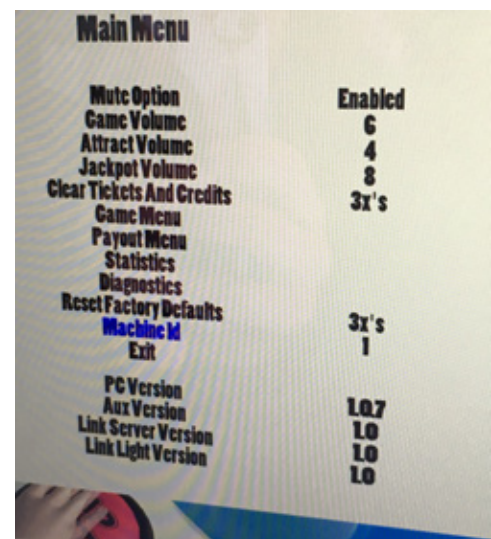

VACUUM AND CLEAN GAME BEFORE POWER ON, TO PREVENT SAWDUST SENSOR INTERFERENCE

DUO LED DIAGRAM

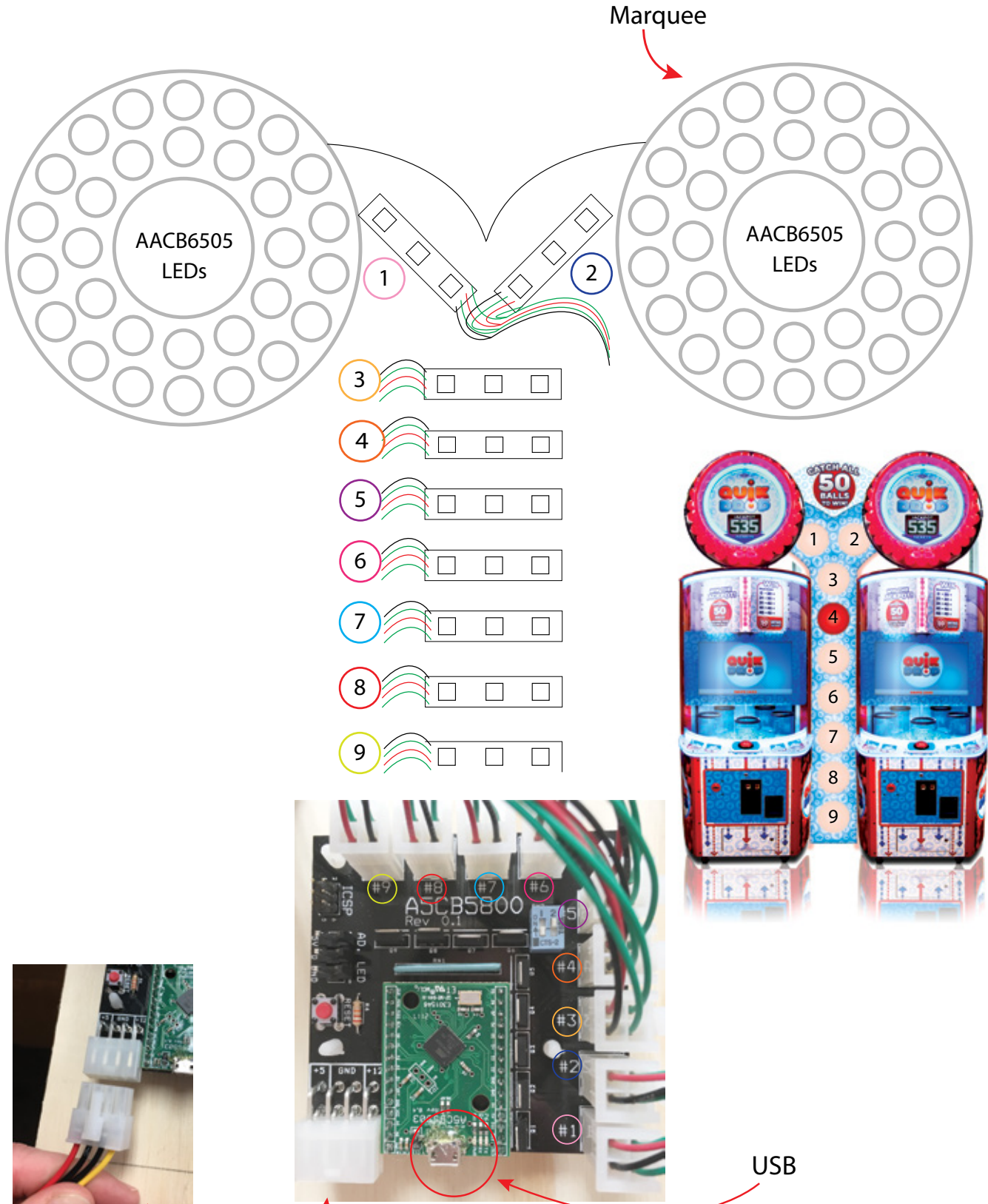

DIP SWITCH SETTINGS

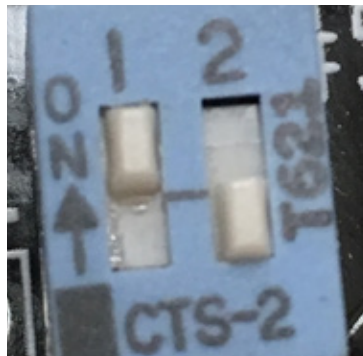

If there is only one quik drop (one marquee) the dip switch settings should be set to 1 as shown above.

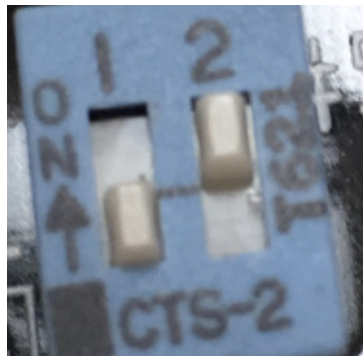

If there is only two quik drop (two marquees linked) the dip switch settings should be set to 2 as shown above.

WIRING DIAGRAM

LINKING KIT

Quick Drop Game

Linking Kit

Quick Drop Game

A5CORD31
Cross Over Ethernet
Between the 2 motherboards



Game Motherboard



AACB5801
LED Lights



AACB5801
LED Lights



AACB5801
LED Lights

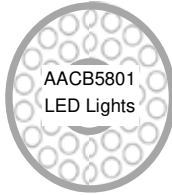

AACB5801
LED Lights

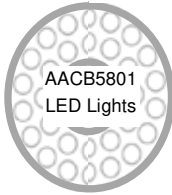

AACB5801
LED Lights

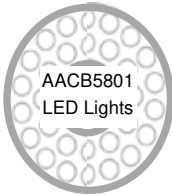

AACB5801
LED Lights



AACB5801
LED Lights

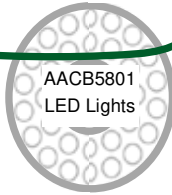

AACB5801
LED Lights

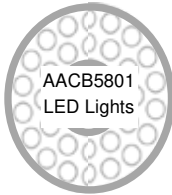

AACB5801
LED Lights

A5CORD31
Cross Over
Ethernet

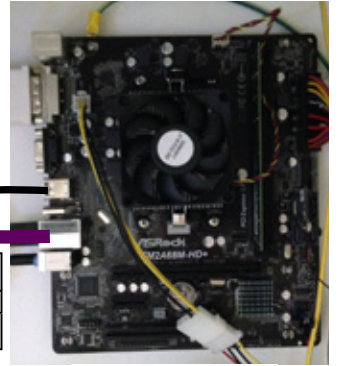

Game Motherboard



A5CORD58
USB Communication



AACB5800
QD Link Controller

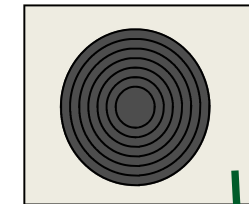

Game Power Supply

AACE5870
Ground Wire

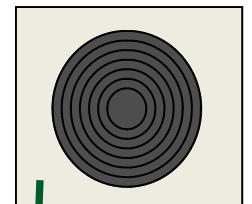

Game Power Supply

AACE5870
Ground Wire

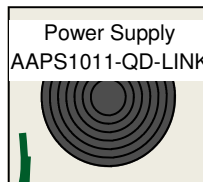

Power Supply
AAPS1011-QD-LINK

TROUBLESHOOTING

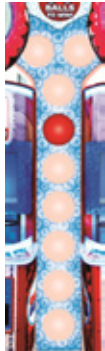
Problem	Probable Cause	Remedy
<p>No power to the unit</p>	<p>Unplugged.</p> <p>Circuit breaker tripped.</p> <p>Line filter faulty.</p> <p>Bad or overloaded power supply.</p>	<p>Check wall outlet cable(A5CORD5) to line filter(A5FI9010) in back of game. Check CE5802 cable to power supply.</p> <p>Reset power strip breaker switch or building circuit breaker. Attempt to determine cause.</p> <p>Replace line filter. (A5FI9010)</p> <p>Refer to Power Supply Diagnostics</p>
<p>Marquee LED lights are not working</p>	<p>LED strip faulty</p> <p>Faulty Cable</p>	<p>Remove marquee and examine LED strip. (AACE6542)</p> <p>Check cables from LED strip to power distribution board. (AACE6542, AACE6533, AACE6500)</p>
<p>Marquee LED's not working 12 Volts DC</p> 	<p>LED strip faulty</p> <p>Faulty Cable</p> <p>Faulty Power Supply</p>	<p>Both LED lights are receiving 12 Volts Dc directly from power supply. Replace LED if needed. (AACE5840)</p> <p>Check cables from LED board to Power Supply (AACE5840, AACE5860)</p> <p>Check for 12 Volts from power supply. Replace Power Supply if needed. (Part # AAPS1011-QD-LINK)</p>
<p>Ball Lights in tower not Working</p> <p>(Power comes from power supply and goes through Link Controller)</p> 	<p>No 5 & 12 volts DC from power supply</p> <p>If all ball lights in tower are not on.</p> <p>If one ball light in tower is not on.</p>	<p>Verify 5 Volts and 12 Volts DC at top plug of Link Controller Board. Replace power supply if needed. (Part # AAPS1011-QD-LINK)</p> <p>Check USB communication cable to motherboard in connecting game. Replace if needed. (A5CORD58)</p> <p>Faulty Link Controller Board Replace Link Controller Board (Part # AACB5800)</p> <p>Swap cable from a working light to verify if socket on Link Controller Board is faulty.</p> <p>If faulty socket, replace Link Controller Board</p> <p>If socket is ok, the cable or LED light is faulty. Check cable and replace if needed. (AACE5861) Replace LED light if needed. (AACB5801)</p>

TROUBLESHOOTING

LINKING ISSUES

If the Quick Drop games are not linking, there are 2 areas to investigate:

- 1.) Menu Settings
- 2.) Physical wire connections

Menu Settings

Please enter the menu of both linked games and compare to the pictures below:

Game # 1

Verify Machine Id is 1 - one game is set to 1, the other to 2.
Verify PC Version is 1.07 or higher
Verify Link Server Version is 1.0 or higher

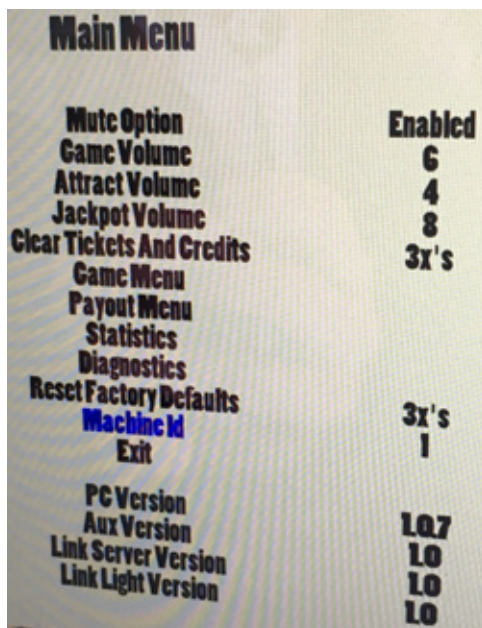

Game # 2

Verify Machine Id is 2
Verify PC Version is 1.07 or higher
Verify Link Server Version is 1.0 or higher

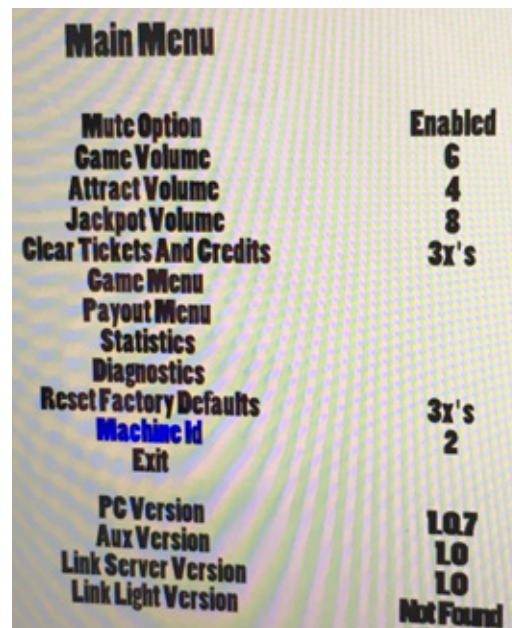

Physical wire connections

Link Server Version: This shows because of the cross-over Ethernet cable connecting the 2 motherboards.
If this is not showing correctly, re-seat the A5CORD31 cross over Ethernet cable into the ports on the motherboards in both games.

Both ports will flash when connection is established.



Link Light Version will only show on the motherboard that is connected via USB cable to the Link Controller board that flashes the ball lights.

DIAGNOSTICS

POWER SUPPLY

- 1.) Verify AC power to power supply through line filter in lower section. Replace if needed. (A5FI9010)
- 2.) Check AC power connection to power supply.
- 3.) Ensure Power Supply switch is set to 115V (or 230V)
(Some model power supplies may not have this)
- 4.) Ensure Power switch is on.

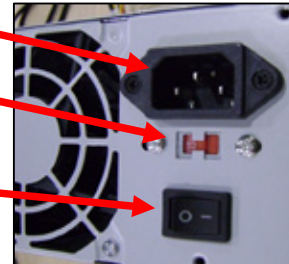

No 12 Volts (Power Supply Fan is not turning), but AC to power supply is OK

This means that either:

- 1.) Power supply is faulty. Verify the green and black wire on power supply harness is tied together.
- 2.) There is a 12 volt short in cabinet causing power supply to remain off to protect itself.

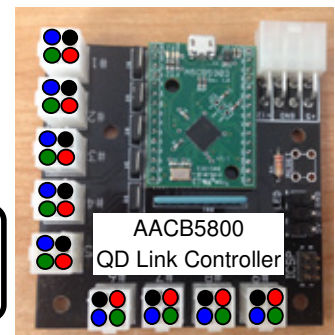
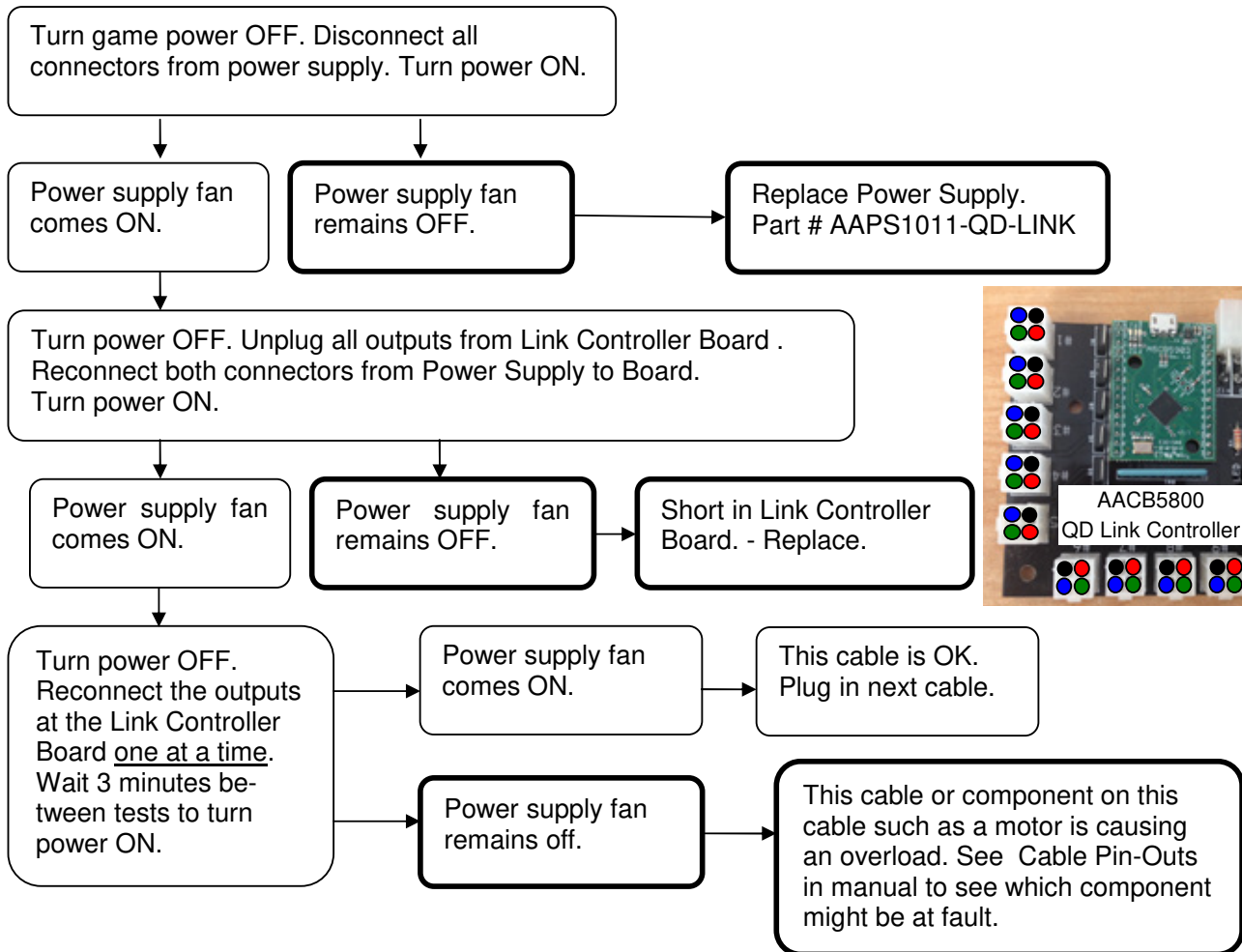

PARTS LIST

PART #	DESCRIPTION
A5BK9999	Bracket, Power Supply Mounting
A5CORD31	Cord, Cross Over Ethernet
A5CORD5	Cord, AC, Computer Cord
A5CORD58	USB Cable , Male to Micro 3 Feet
A5DE5822	Decal,Bottom Divider,Qd Link Marq
A5DE5823	Decal,Top Connector,Qd Link Marq
A5DE5824	Decal,Top Marquee,Qd Link Marq
A5DE5825	Decal, Qd Duo Kit Strip Drill Temp
A5FI9010	Filter, F1700ca06, Inline
A5KIT-QDDUO	Hardware Kit, Qd Duo Linking Kit
A5VF6501	Vacuum Form, Dome (R7sd4)
AACB5800	Assy,Pcba,Qd Link Marquee Controller
AACB5801	Red Ball Lights Board
AACE5840	Cable,L & R Instruction Led Cable
AACE5860	Cable Assy, Power To Mini Stick Light
AACE5861	Cable Assy, Button #1 Power
AACE5862	Cable Assy, Button #2 Power
AACE5863	Cable Assy, Button #3 Power
AACE5864	Cable Assy, Button #4 Power
AACE5865	Cable Assy, Button #5 Power
AACE5866	Cable Assy, Button #6 Power
AACE5867	Cable Assy, Button #7 Power
AACE5868	Cable Assy, Button #8 Power
AACE5869	Cable Assy, Button #9 Power
AACE5870	Cable Assy,Link Ps To Rosewill Ps Ground
AACE5872	Cable Assy, Power Splitter, Qd Link
AAPS1011-QD-LINK	Cable Assy, QD Link Kit Power Supply

TECHNICAL SUPPORT

Excellent customer service is very important to Bay Tek Games!

We know that keeping your games in great operating condition is important to your business. When you need us, we are here to help. You can call us for free technical assistance, and you can count on us to have parts on-hand to support your game. We offer options that fit your needs.

Electronics / Circuit Boards - Repair Options

Repair & Return – If you have Circuit Board issues with your Bay Tek game, you can send the board to us and we'll repair it right away. Most items sent to us are repaired and returned to you within two days. This option is your best value as we offer this fast turn-around service at the most reasonable price.

Advance Replacement – If you have Circuit Board issues with your Bay Tek game, but you don't have time to send in your board in for repair, give us a call and ask for an Advance Replacement. We'll send you a replacement board that same day (pending availability). When you get your new board, just repackage the defective board in the same box and send it back to us. We make it easy by including a UPS Return Shipping label for you to put on the box (not available for international shipments). This is your best option when you need to get your game up and running as quickly as possible!

Spare Parts – Take matters into your own hands and purchase new spare Circuit Boards for your Bay Tek games. Many of our games share the same main-board electronics. This means you can buy one set of spare electronics to support many of your Bay Tek games. Spare boards allow you to get your game up and running the quickest and provide you a valuable troubleshooting option. Call our technicians to get recommendations for what you should keep on hand for spare parts!

Technical Support:

“You” are the best tool for troubleshooting! Your abilities to understand the game and your skills to repair the game are invaluable to us! If you need help, you know you can call us. It's not easy to diagnose a game remotely by phone, but our technicians do a great job. They'll need your help to perform some troubleshooting steps and convey to them exactly what's happening with your game.

Returns, Credits, & Fees:

NOTICE! ALL ITEMS being sent to Bay Tek Games for repair or return, etc. require prior Return Authorization! Bay Tek Games will provide a Product Return Form with an authorizing Ticket Number for each item to be returned. Please be certain to include this document with all shipments!

Late Fees and Non-Return Fees - Advance Replacement and Warranty Replacement items require the defective items to be returned by Bay Tek games promptly to avoid Late Fees. We expect items to be returned with 10 working days. Late fees are invoiced monthly. Late fees are non-refundable under any circumstance! Any item not returned within 90 days will be invoiced in full as a replacement part.

Bench Fees - Bench fees will apply for each electronic item returned to Bay Tek Games (this includes unused Advance Replacement items). This charge covers our cost to inspect, evaluate and retest each item. Please note that returned items that do not pass our tests will be charged accordingly as replacement items or advance replacements.

Restocking Fees - Unused items returned for credit will be credited minus a restocking fee. Items must be returned within 30 days of purchase in order to qualify for any credit amount. No shipping charges will be credited.

WARRANTY

Bay Tek Games warrants to the original purchaser that all game components will be free of defects in workmanship and materials for a period of 6 months from the date of purchase. If you fill out the registration card in the cashbox of the game, Bay Tek will add another 3 months to your warranty, free of charge.

Bay Tek Games will, without charge, repair or replace defective component parts upon notification to the parts/service department while the game is under warranty.

Warranty replacement parts will be shipped immediately, via ground service, along with a Product Return Form for the return of defective parts.

Defective parts must be shipped back to Bay Tek Games unless otherwise instructed. Items not returned to Bay Tek Games will be invoiced as replacement parts.

This warranty does not apply in the event of any misuse or abuse to the product, or as a result of any unauthorized repairs or alterations. The warranty does not apply if any serial number decal is altered, defaced, or removed from its original position.

 **ATTENTION** 

In order to maintain the safety & compliance certifications of this game, **ONLY** approved parts may be used. For approved replacement parts, refer to the parts list in this manual.

Should you need your game serviced, determine the serial number from the decal placed on the front of this manual, or locate it on the back of the game. Then contact our Service Department at: 920.822.3951 or e-mail: service@baytekgames.com

NON-WARRANTY

Options and estimated charges will be provided to you for your approval.

Please remember that any items being sent to Bay Tek Games must include prior return authorization from our Parts & Service Department.

This approval will include a Product Return Form which is required to be included with any incoming shipments. Repaired parts will be shipped back using the same method in which they were received.

Repairs are warranted for 30 days from the date of return shipment.